



Steelo

2024

Ficha técnica
Fiche technique
Technical specifications

JG Open
Systems

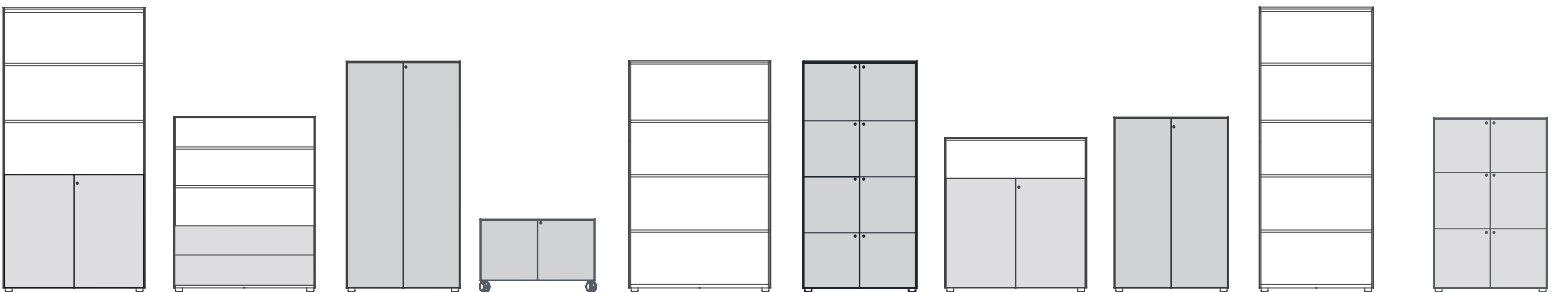

STEELO

SteeLO is a metallic storage system with multiple solutions that brings a touch of sophistication and modernity to workspaces. The design of the Steelo range represents the essence of JG, born as a manufacturer of metal products and positioned as a reference and expert in the field. Steelo is a timeless redesign of the classic metal cabinets that responds to all the existing needs in today's offices. Characterised by its straight lines and elegant style, the Steelo range manages to be versatile, offering an attractive, functional and sustainable storage system with multitude of models that allow total compositional freedom in the office and that combined with accessories such as whiteboards and acoustic rear panels, as well as their charming and vibrant finishes, will create the ideal environment for any office.

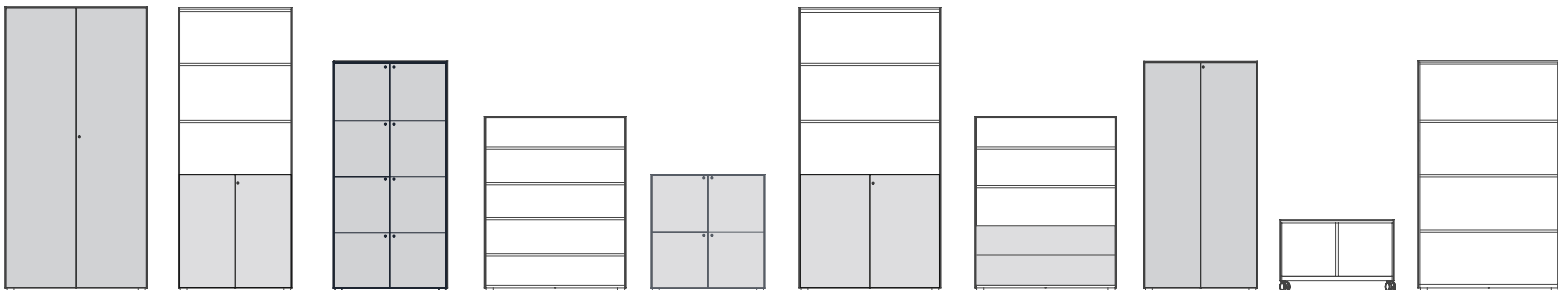

Typologies

H45 – 50

Storage system made with cold rolled steel sheets that includes levelers (height 44.5 cm) or wheels (height 50 cm). Available in width 80 cm with or without doors.

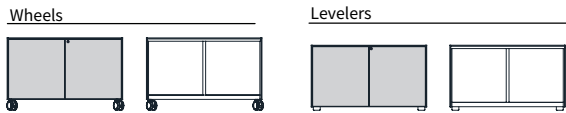

H72

Steel cabinets in height 72 cm with levelers, available in three variations: hinged doors, shelves or drawers with different widths.

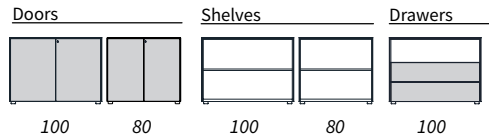

H107

Cold rolled steel cupboards in height 107 cm and widths 80 and 100 cm for hinged doors, shelves, both (mixed) or drawers.

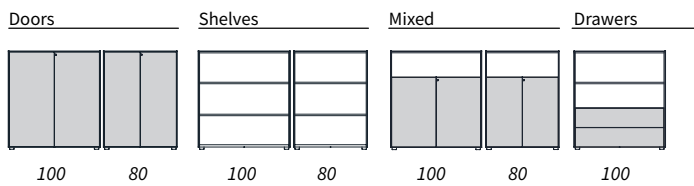

H122

Steel cupboards with 122 cm of height and length 80 or 100 cm available in 7 different options.

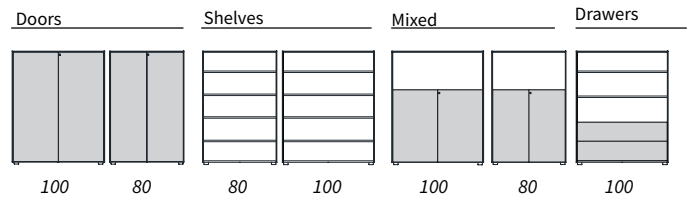

H162

162 cm high cupboard with length 80 or 100 cm available in 7 different variations.

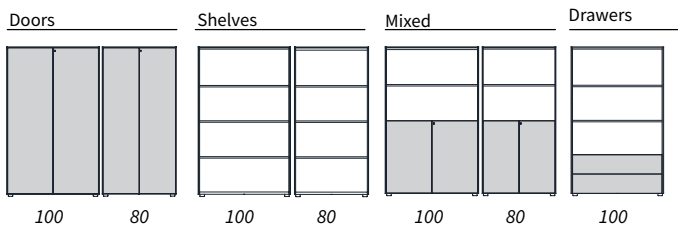

H200

Cupboard in 200 cm of height and width 80 or 100 cm available with hinged doors, shelves, both combined in the mix option and drawers.

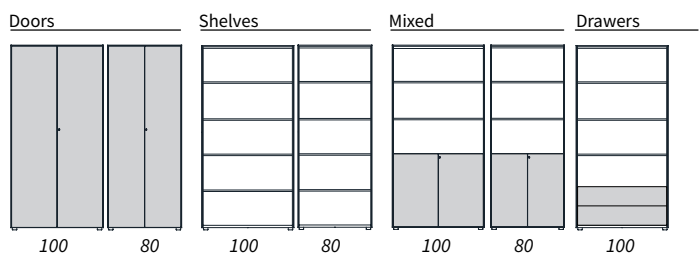

LOCKERS

Steel lockers in width 80 cm available in three different heights: 83 cm (4 doors), 122 cm (6 doors) and 162cm (8 doors).

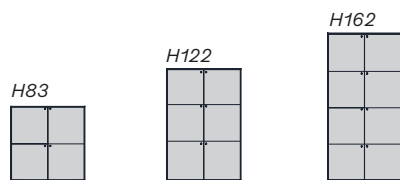

General Characteristics

The Steelo series provides a great variety of storage system options such as cabinets or lockers, the structure in both of these models is made out of steel sheets and available in various metallic finishes*. For both the cabinets and lockers the front parts such as doors can be made in steel sheets (same finish as the structure), melamine or slotted melamine.

All the cabinets come with 55 mm-diameter plastic levelers adjustable from the inside using an Allen key. 70 kg load capacity and 20 mm height adjustment per leveler.

*See finishes section in pg.9

General Characteristics

Width: 80 and 100 cm (depends on height)

Depth: 45,4 cm.

Cabinet heights: 44.5 - 50, 71.7, 106.7, 122.2, 161.7 and 199.7 cm.

Locker heights: 82.6 122.2 and 161.7 cm.

Surface cover

Epoxy powder paint of 80 microns with preliminary phosphate antioxidant treatment.

Doors
Metallic
 Made with 0,8 mm thick steel sheets and covered with epoxy paint

Melamine
 19 mm thick melamine board with a 2 mm edge

Interior sides
 0,7 mm thick steel sheets with a completely smooth surface. The sides have markings that make the assembly of the shelf holders easier

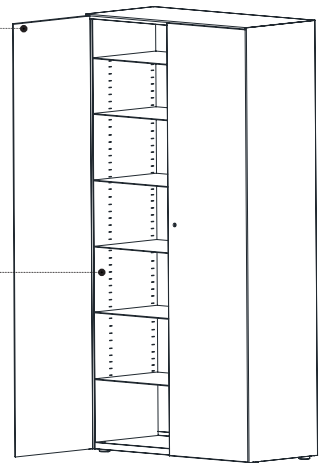

Packaging and Assembly

The series comes pre-assembled with its doors already built in to reduce assembly time, which depending on the model, is estimated to be between 5 and 10 minutes. The remaining parts to be assembled are the shelves, the locks and the accessories in most cases. The levellers are adjusted with precision from above with an Allen key.

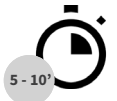

In order to protect all the elements of the series, custom corner pieces and profiles have been designed. The packaging is made up of two cardboard covers, one for the top and one for the bottom and 4 reinforced cardboard profiles to protect the sides. The package is covered with shrink plastic.

Double Doors and Combination Cabinets

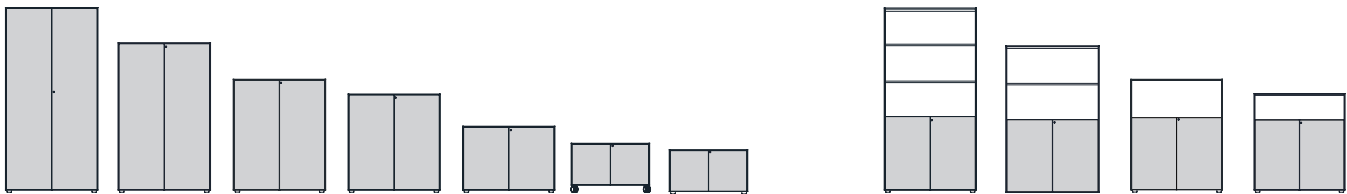

TYOLOGIES

Classic hinged doors available in all the door cabinet models of the Steelo series and lockers. They are also included in the mixed cabinet range, the result of combining the shelf cabinet with the hinged door model. The doors are placed on the outer part of the metal structure.

MATERIAL

Doors are made with 0,8 mm thick cold rolled **steel** sheets, 19 mm thick **melamine** boards or **slotted melamine** with black MDF interior and grooved machining for slatted finish (slotted doors available only in Aurora Oak (RA), Jet Oak (RZ) and Matt Black (NM)).

HINGES

Damped hinges designed to close doors smoothly and silently. These hinges are built in by default.

HANDLES

Lock with hinged key

Single point anchor lock with transparent plastic folding key, compact and aesthetically pleasing that combines perfectly with the unit. The key features the JG logo and the lock has aluminium finishes.

This key is anchored when the lock is open and incorporates a pivoting embellisher that acts as a handle. In order to avoid aesthetic differences between handles, we have opted for a protruding lock and a consistent design in both options.



Door knob

As an alternative for the lock a single door knob can be placed on the right door instead. It is available in stainless steel or black. Not compatible with hinged key lock.

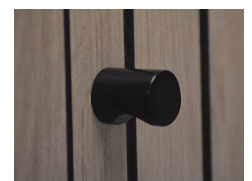

Drawer Cabinet

The drawers include guides with the Stop Control system, an integrated self-closure for automatic closing. The drawer's thin handles keep the Steelo's refined aesthetic. Capacity up to 40 kg.

Front finishes: All metal finishes, melamine and slotted melamine.

Handle finishes: same finish as the structure.

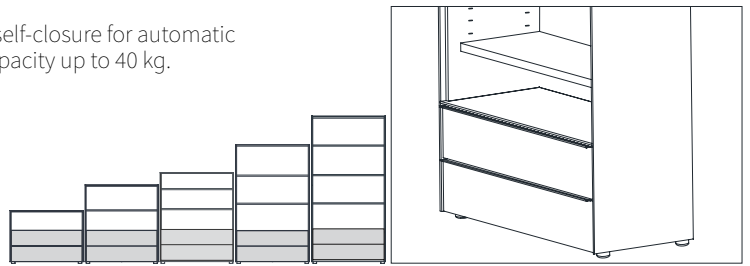

H50 Cabinet with Wheels

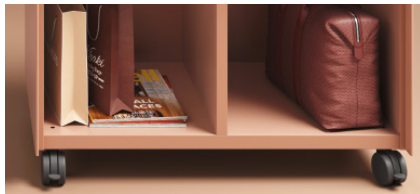

The 50 cm high Steelo is fitted with newly designed self-braking wheels of 65 mm in diameter, which are optional in all combinations of the 50 cm model. Each wheel has 50 kg load capacity. They are available in black with soft PU tread. Not compatible with other Steelo heights.



Lockers

HINGES

Damped hinges designed to close doors smoothly and silently. These hinges are built in by default.

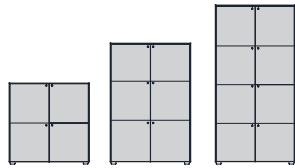

LOCKS (/ *6A - / *6B - / *6C)

There are up to three different types of locks for the lockers:



Manual lock with JG logo (6A*)



Manual numerical lock and key (6B*)



Electronic numerical lock (6C*)

Accessories

SHELVES

Metal filing shelf with a thickness of 30 mm. Composed of a metal sheet with uniform thickness. Suitable for hanging folders.

Finishes: Available in all metal finishes.

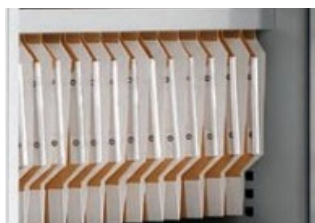

VERTICAL DIVIDER ACCESSORY

Metallic accessory with vertical dividers of height 35 cm, available in lengths of 100 and 80 cm. Includes a slim shelf for placement.

Finishes: Available in all metal finishes.



Metallic slim shelf with a thickness of 18 mm. Composed of metal sheet. Not compatible with hanging folders.

Finishes: Available in all metal finishes.



TOPS

Tops for all heights and widths 80 and 100 cm.

Finishes: All melamines.



Accessories

MAGNETIC WHITEBOARD WITH METAL ACCESSORY

Whiteboard with magnetic adjustment for the rear of the cabinet. Available only in white.

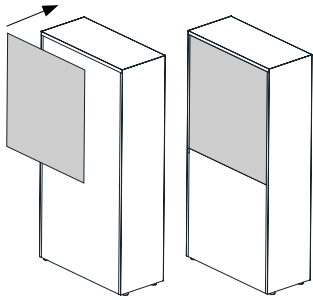

Compatibility
162 cm high cabinets.
 Width Dimensions
80 (75 x 82,5 cm)
100 (95 x 82,5 cm)

200 cm high cabinets.
 Width Dimensions
80 (75 x 102,5 cm)
100 (95 x 102,5 cm)

Support made with folded steel sheets of 1.2 cm in thickness covered with epoxy paint. It is fixated below the whiteboard with double-sided tape. The support is used as storage for the material to write on the board.

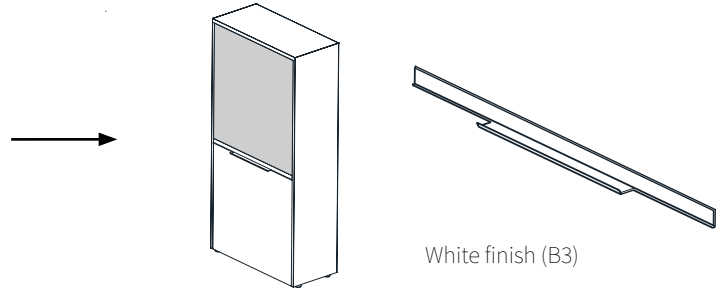

STEELO FEET ACCESSORY

Angular design feet made of aluminum alloy (Zamak) with chrome levelers adjustable by hand.

Finishes: Same finish as the structure.

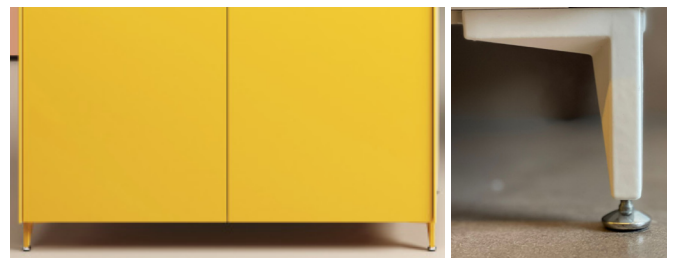

PLANTER

Planter for artificial plants measuring 80/100 x 45 x 15h cm in metal and 80/100 x 45 x 14.5h cm in PET.

Finishes: metal and S-THREE panels (PET).



CUSHION

Cushion made with a base of melamine and covered with foam and upholstery S-TWO ERA designed to be used as a seat on top of the cabinets of 45 -50 cm high.

Finishes: All upholstery S-TWO ERA.

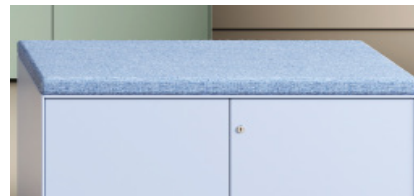

Acoustic accessories

ACOUSTIC REAR SIDE

Acoustic panels positionable in the front and the rear sides of the Steelo models, attachable to cabinets with built-in magnets, making them easy to exchange or remove. The panels are available in S-TWO and S-THREE upholstery (PET) for the entire Steelo range. The interior rears can be used also on the exterior for all models with a few exceptions; mixed cabinets H200 and H162 (*1) and all in H50-45 (the latter are not compatible with acoustic rears).

*1. In mixed models, the interior back panel is different from the exterior one, which only covers the visible part. Available only for mixed cabinets H200 and H162.

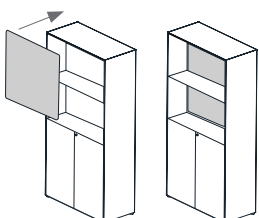

Combination cabinet interior (1*)

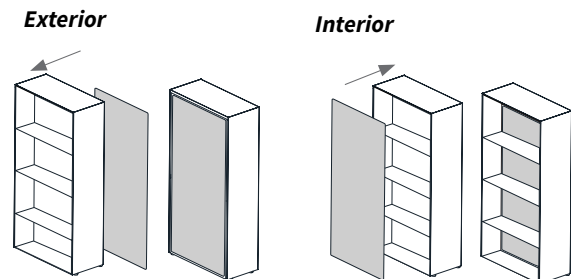

External and internal backs of width 80 and 100 cm. Available for cabinets with a height:

- 72 cm
- 82 cm (80 cm wide only)
- 107 cm
- 122 cm
- 162 cm
- 200 cm

Acoustic accessories

UPHOLSTERY S-TWO

DUO

The fabric and the surface finish is made with 40% wool and 60% viscose. Available in 5 finishes.

- Specific weight: 250 g/m.l
- Fabric density: 173,6 kg/m3

ERA

The surface fabric is polyester. Available in 4 finishes.

- Composition: 100% polyester. Non-metallic dyes.
- Specific weight: 320 g/m.l



ACOUSTIC PET S-THREE

The S-THREE upholstery is made with recycled PET 60% of which is obtained from plastic bottles. For each m2 of material, up to 55 plastic bottles are recycled. Available in 9 finishes.

- Thickness 9mm
- Weight: 1,9kg/m2
- Fabric density: 210kg/m2



There are two groups depending on the finish:

- **EASY** (standard price and delivery)
- **PROJECT** (price and delivery according project)



Acoustic test

Study to determine the acoustic absorption values of S-TWO and S-THREE panels in accordance with ISO 354:2003 in an empty room lined with the panels. The angle of acoustic panels provided helps to significantly reduce the underlying noise level and reverberation time in the room to make conversations in the office more easily intelligible.

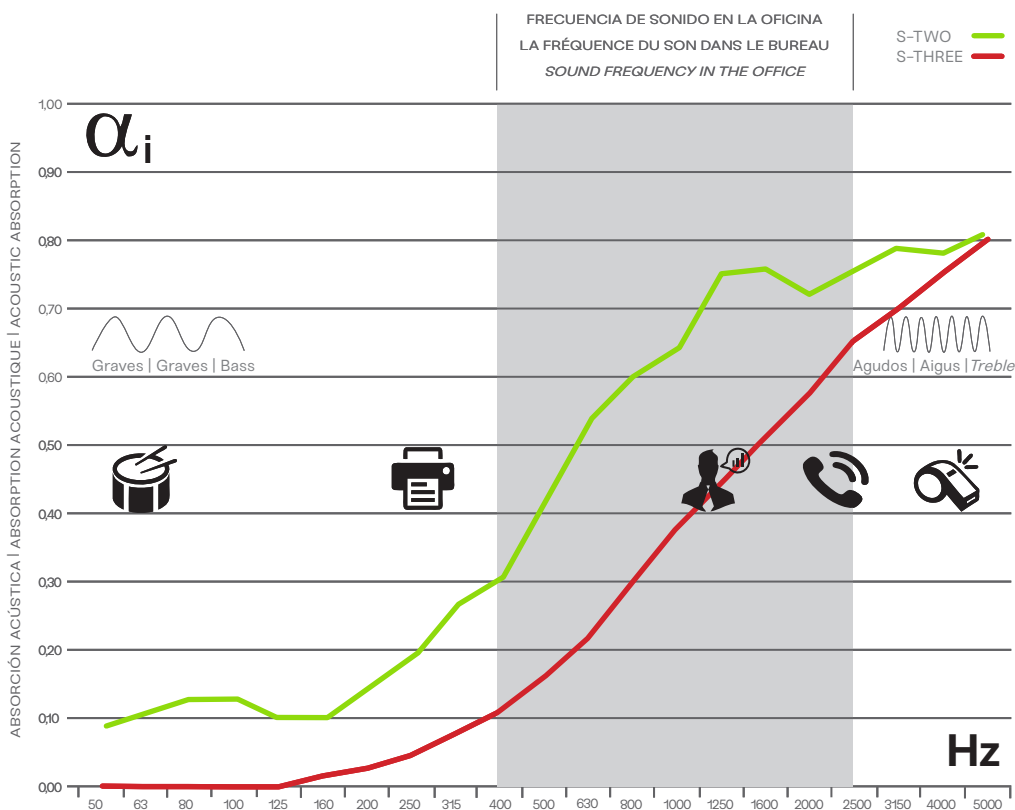

Maintenance, Quality and Ecology

Our company has the quality certification **ISO 9001** and **TECNALIA** for years, institution that verifies and standardizes raw material and compliance with European norms applicable to office furniture.

Regarding to environmental policy, our company has implemented and certified all the measures contained in the **ISO 14001** and **ISO 14006**. Compliance with these standards facilitates obtaining LEED points with our products.

The most suitable for cleaning our furniture is the use of a clean microfiber cloth, slightly moistened with water, without any additional cleaning products. If some dirt is rather difficult to remove, use the same microfiber cloth or a 100% cotton one slightly moist with water and a little neutral soap or window-cleaning fluid (except natural wood). Then, dry the furniture with another soft, dry cloth.

All the products that contain ammonia, caustic or solvent products are not recommended at all. The cleaning products made specifically for furniture usually contain substances like wax to enhance the shine of natural wood surfaces that has been damaged by use and are timeworn, but such substances can give the furniture a greasy look and cause irreversible effects on it. Therefore these are also not recommended.



Recyclable

The components in our furniture are easy to separate out and recycle.



Production

Production processes that are environmentally friendly.



Use

Our products are ergonomic and safe for users.



Transport

We minimize the impact of transport and packaging on the environment.



Materials

Recycled materials and secondary metals.

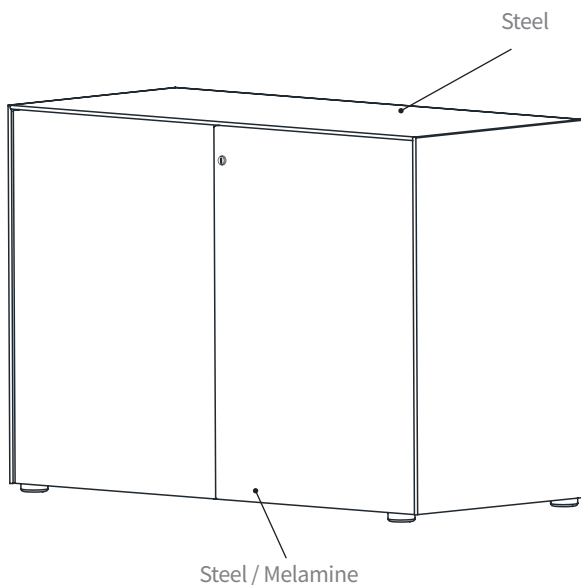

MATERIAL	RECYCLED RAW MATERIAL (%)	RECICLABILIDAD A FIN DE VIDA (%)
Steel	20-30%	100%
Melamine	30%	100%
PET	60%	100%



Certified company in management system, quality and environment by:



Sistema de Gestión
 ISO 9001:2015
 ISO 14001:2015
 www.tuv.com
 ID 1100008125