

Guía de Producto

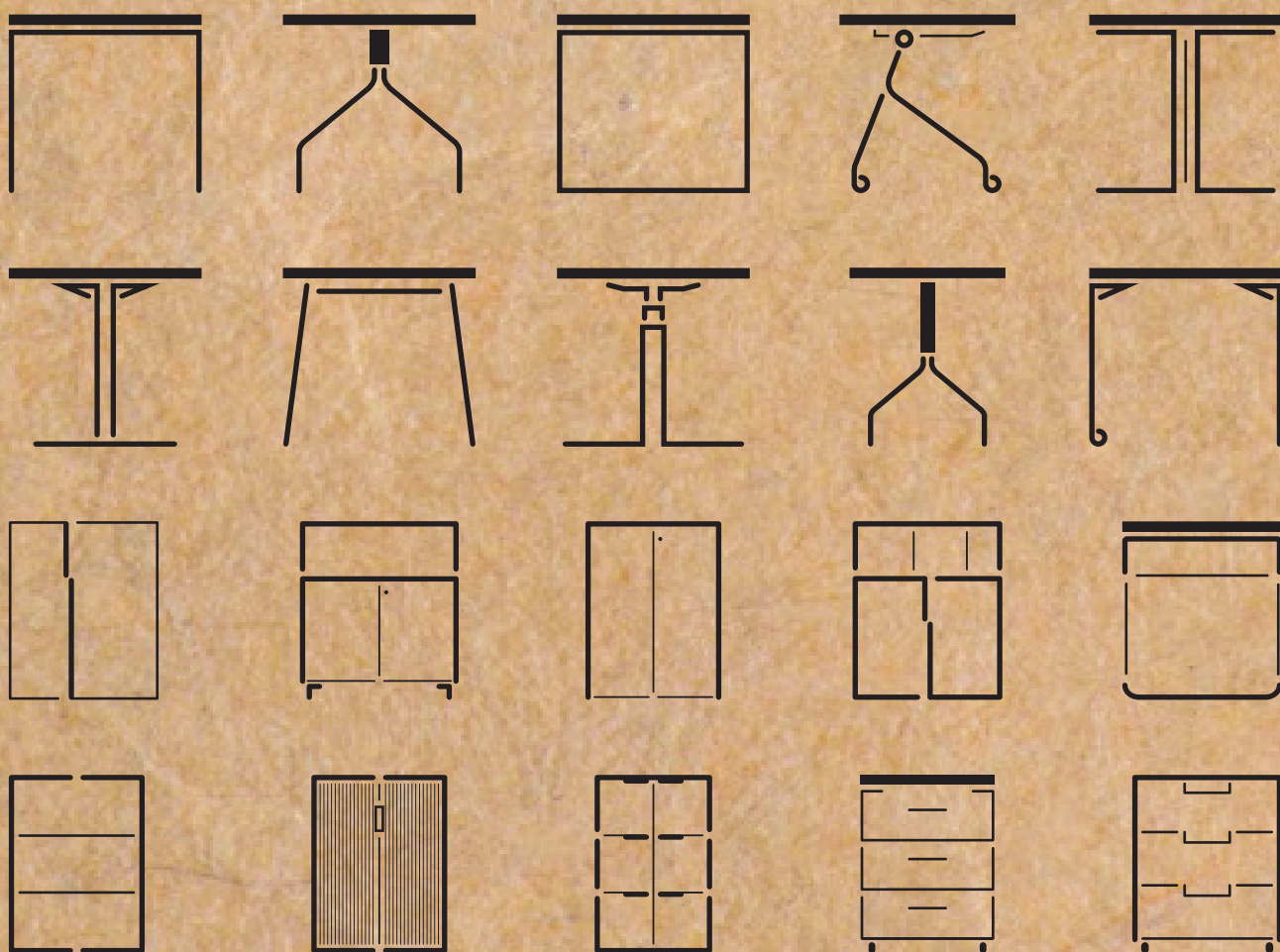

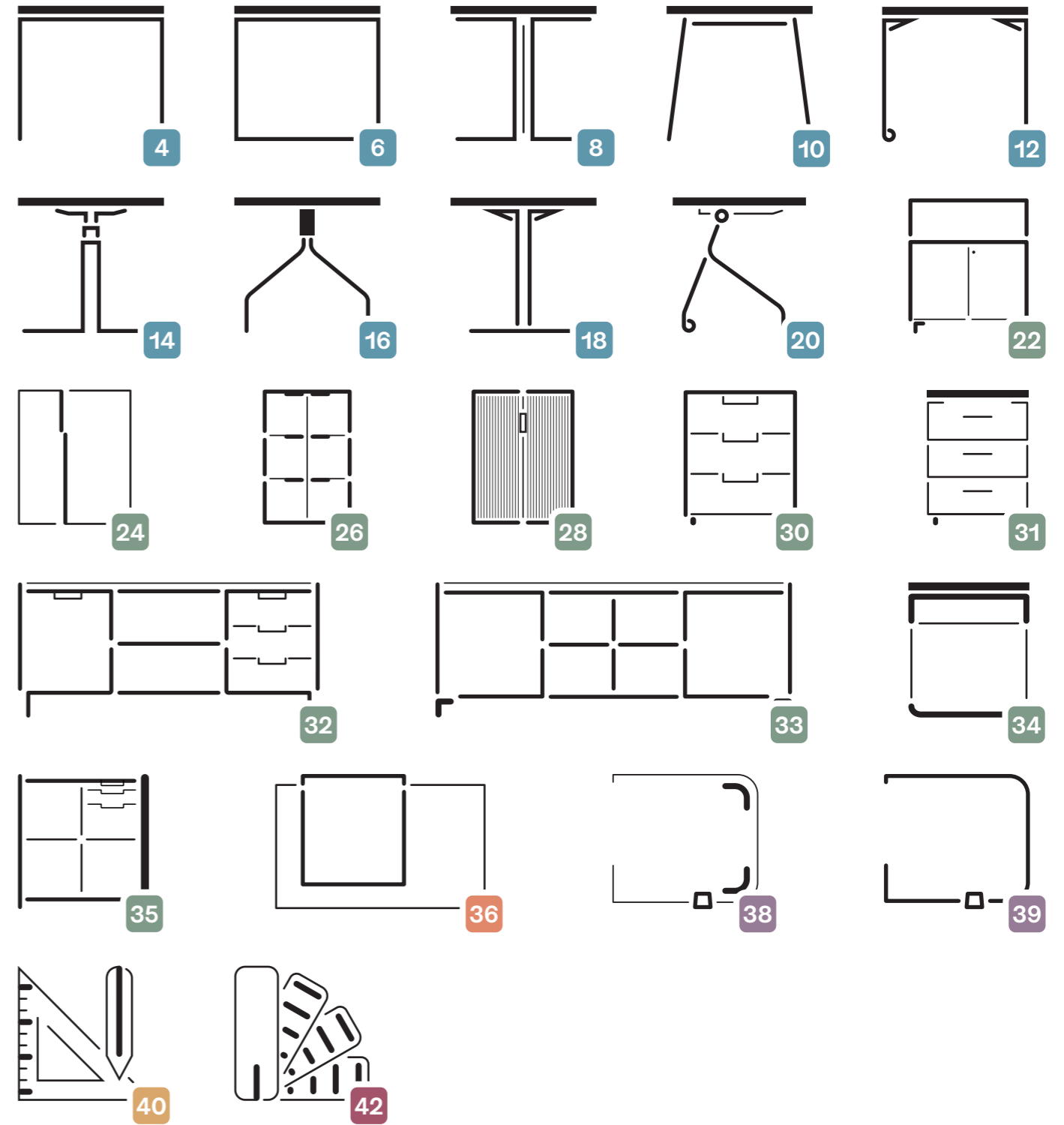





Mapa de producto



Dentro de la política de mejora continua de nuestros productos, JG se reserva el derecho de hacer modificaciones técnicas y estéticas en la gama presentada.

Dans le cadre de la politique d'amélioration continue de nos produits, JG se réserve le droit d'apporter des modifications techniques et esthétiques à la gamme présentée.

Within the policy of continuous improvement of our products, JG reserves the right to make technical and aesthetic changes in the range presented.

- | | | |
|---|---|---|
|  Mesas / Bureaux / Desks |  Almacenaje / Rangement / Storage |  Mostradores / Banques d'accueils
Reception desks |
|  Paneles / Panneaux / Panels |  A medida / Sur mesure / Custom made |  Acabados / Finitions / Finishes |

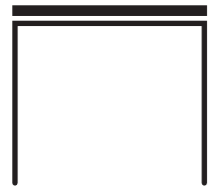

Adapta+

Todo en uno para tu oficina

Mesas

- Operativas
- De dirección
- De reunión



SISTEMA DE MESAS CON ESTRUCTURA METÁLICA. DISEÑO DE PATA EN FORMA DE "U INVERTIDA"
 SYSTÈME DE BUREAUX À STRUCTURE MÉTALLIQUE. DESIGN DU PIÈTEMENT EN "U" INVERSÉ
 DESK SYSTEM WITH METALLIC STRUCTURE. "INVERTED U" LEG DESIGN

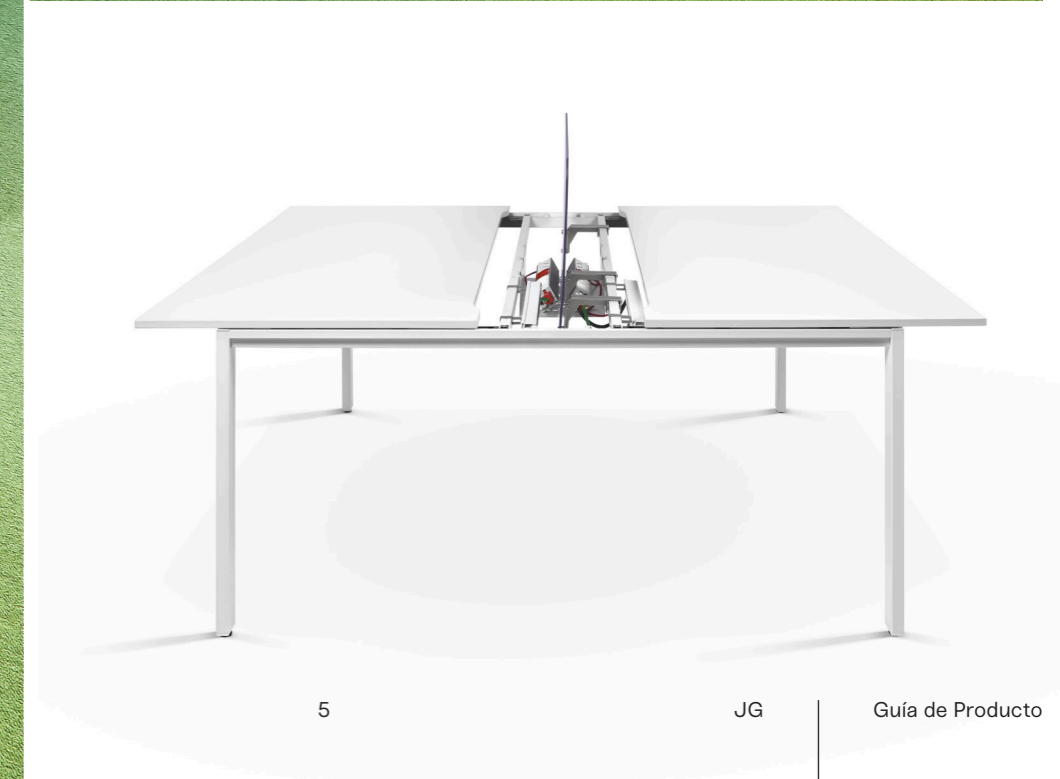

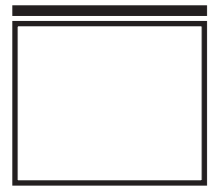

Adapta 2+

Con identidad propia

Mesas

- Operativas
- De dirección
- De reunión

SISTEMA DE MESAS CON ESTRUCTURA METÁLICA. DISEÑO DE PATA PERIMETRAL CON FORMA RECTANGULAR
 SYSTÈME DE BUREAUX À STRUCTURE MÉTALLIQUE. DESIGN DU PIÈTEMENT PÉRIMÉTRAL, FORME DE CADRE
 DESK SYSTEM WITH METALLIC STRUCTURE. PERIMETER LEG DESIGN WITH RECTANGULAR SHAPE

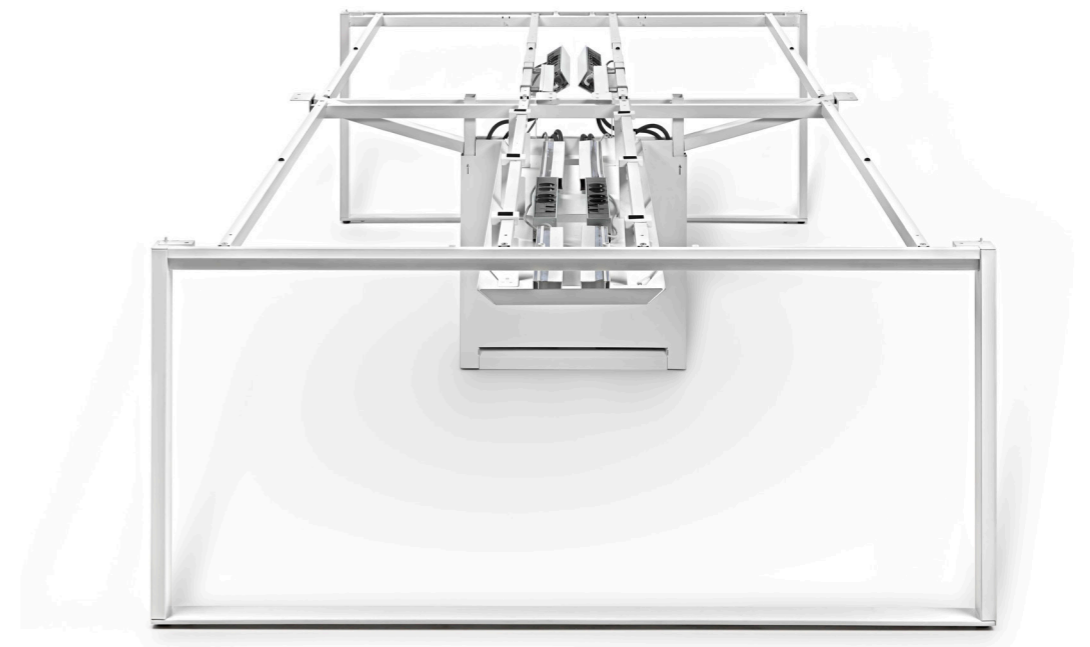



TWork

La belleza de la simetría

Mesas

- Operativas
- De dirección
- De reunión



SISTEMA DE MESAS CON ESTRUCTURA METÁLICA. DISEÑO DE PATA EN FORMA DE "T INVERTIDA"
 SYSTÈME DE BUREAUX À STRUCTURE MÉTALLIQUE. DESIGN DU PIÈTEMENT EN "T INVERSÉ"
 DESK SYSTEM WITH METALLIC STRUCTURE. "INVERTED T" LEG DESIGN



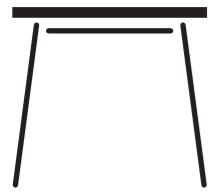

Ysos

Un nuevo ángulo en la oficina

Mesas

- Operativas
- De dirección
- De reunión



SISTEMA DE MESAS CON ESTRUCTURA METÁLICA. DISEÑO DE PATA EN POSICIÓN INCLINADA
SYSTÈME DE BUREAUX POLYVALENT À STRUCTURE MÉTALLIQUE. CONCEPTION DE PIÈTEMENT INCLINÉ
DESK SYSTEM WITH METALLIC STRUCTURE. INCLINED LEG DESIGN



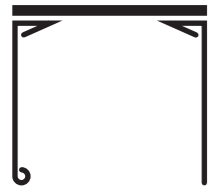

Modul

Imagina y crea tus espacios

Mesas

- Operativas
- De dirección
- De reunión
- Polivalentes



SISTEMA DE MESAS POLIVALENTES CON ESTRUCTURA METÁLICA. DISPONIBLE CON Y SIN RUEDAS O COMBINABLES
 SYSTÈME DE BUREAUX POLYVALENTS À STRUCTURE MÉTALLIQUE. DISPONIBLES AVEC OU SANS ROULETTES, ET COMBINABLES
 MULTIPURPOSE DESK SYSTEM WITH METALLIC STRUCTURE. AVAILABLE WITH AND WITHOUT WHEELS OR COMBINABLE



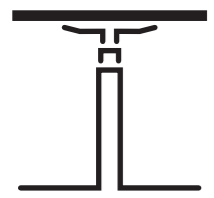

TCare

¿Necesitas altura?

Mesas

- Operativas
- De reunión
- Regulables en altura

MESA REGULABLE EN ALTURA CON SISTEMA DE ELEVACIÓN ELECTRÓNICO. DISEÑO DE PATA EN FORMA DE "T INVERTIDA"
BUREAU RÉGLABLE EN HAUTEUR AVEC SYSTEME D'ÉLEVATION ÉLECTRONIQUE. DESIGN DU PIÈTEMENT EN "T INVERSÉ"
HEIGHT ADJUSTABLE DESK WITH ELECTRONIC ELEVATION MECHANISM. "INVERTED T" LEG DESIGN



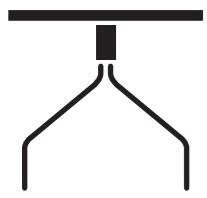

Joy-in

Conecta con tu ritmo

Mesas

- De reunión
- Polivalentes

MESA MULTIFUNCIONAL FIJA O MÓVIL CONFIGURABLE EN ALTURA
 TABLE MULTIFONCTIONNELLE FIXE OU MOBILE À HAUTEUR CONFIGURABLE
 FIXED OR MOBILE MULTIFUNCTIONAL TABLE CONFIGURABLE IN HEIGHT



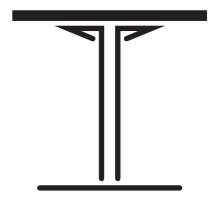

Cuadrat

Trabajar, compartir y descansar

Mesas

- De reunión
- Polivalentes

MESAS DE REUNIONES POLIVALENTES RECTANGULARES O CUADRADAS. DISPONIBLES EN 2 ALTURAS
TABLES DE RÉUNION POLYVALENTES RECTANGULAIRES OU CARRÉES. DISPONIBLES EN 2 HAUTEURS
RECTANGULAR OR SQUARE MULTIPURPOSE MEETING TABLES. AVAILABLE IN 2 HEIGHTS





2Move

Máxima polivalencia

Mesas

Polivalentes

MESA ABATIBLE CON RUEDAS
TABLE RABATTABLE À ROULETTES
FOLDING TABLE ON WHEELS

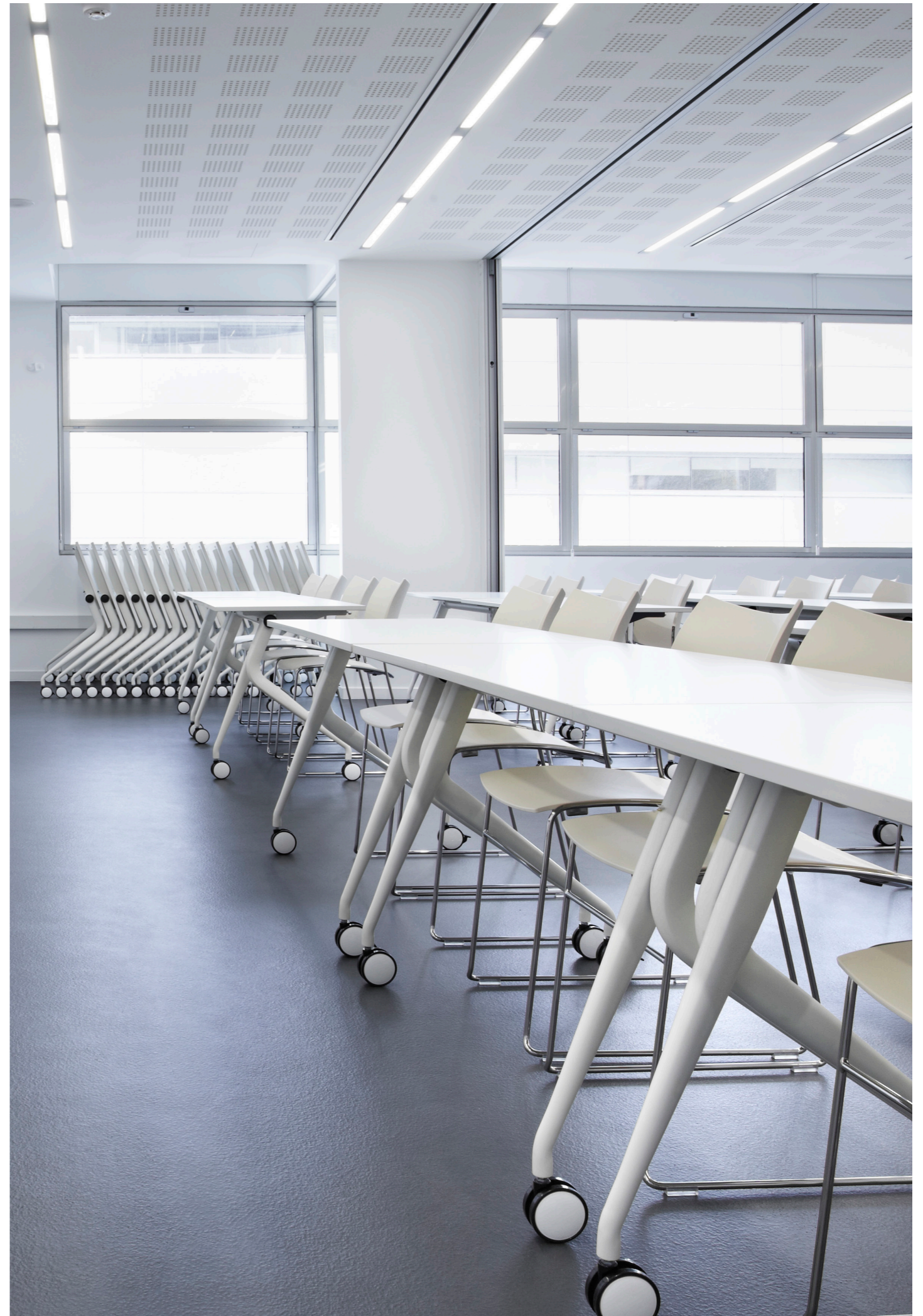
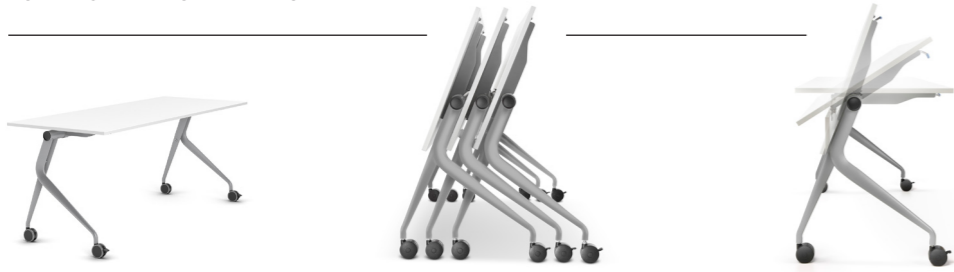

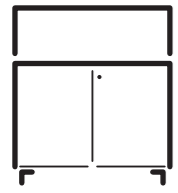

Steelo

El color define tu Steelo

Almacenaje

Sistema de
modulos
metálicos

SISTEMA DE ALMACENAJE CON ESTRUCTURA METÁLICA QUE COMBINA ARMARIOS Y LOCKERS
SYSTÈME DE RANGEMENT COMBINANT ARMOIRES ET CASIERS EN STRUCTURE MÉTALLIQUE
METAL STRUCTURE STORAGE SYSTEM COMBINING CUPBOARDS AND LOCKERS



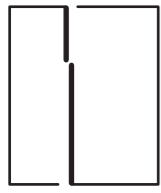

60/40

Pasión por el almacenaje

Almacenaje

Sistema de almacenaje laminado

SISTEMA DE ALMACENAJE LAMINADO FRONT-OFFICE CON MÚLTIPLES SOLUCIONES Y ACCESORIOS
SYSTÈME DE RANGEMENT FRONT-OFFICE EN MÉLAMINÉ AVEC DE MULTIPLES SOLUTIONS ET ACCESSOIRES
LAMINATE FRONT-OFFICE STORAGE SYSTEM WITH MULTIPLE SOLUTIONS AND ACCESSORIES



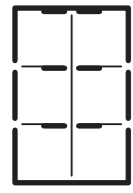

Frames

Un locker para todos

Almacenaje

Locker laminado

LOCKER LAMINADO FRONT-OFFICE. OPCIÓN CON PUERTAS SIMÉTRICAS Y ASIMÉTRICAS
CASIER MÉLAMINÉ FRONT-OFFICE. OPTION AVEC PORTES SYMÉTRIQUES ET ASYMÉTRIQUES
LAMINATE FRONT-OFFICE LOCKER. OPTION WITH SYMMETRICAL AND ASYMMETRICAL DOORS



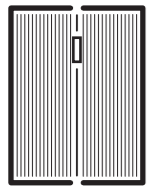

PV Plus

Un referente del sector

Almacenaje

Armario metálico de persiana

ARMARIO METÁLICO DE PERSIANA CON APERTURA LATERAL
ARMOIRE MÉTALLIQUE À RIDEAU PVC À OUVERTURE LATÉRALE
METAL SIDE-OPENING TAMBOUR CABINET



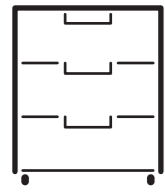

Qbuc

Un imprescindible para tu mesa

Almacenaje

Cajonera metálica

CAJONERA DE ESTRUCTURA METÁLICA. OPCIÓN CON FRENTES METÁLICOS O LAMINADOS
CAISSON MÉTALLIQUE. FAÇADE DES TIROIRS EN MÉTAL OU EN MÉLAMINE
METAL FRAME DRAWERS. OPTION WITH METAL OR LAMINATED FRONTS



CP

Un clásico en la oficina

Almacenaje

Cajonera laminada

CAJONERA LAMINADA CON TIRADOR DE ASA
CAISSON MÉLAMINÉ AVEC POIGNÉE DE TIRAGE
LAMINATED PEDESTALS WITH HANDLE PULL



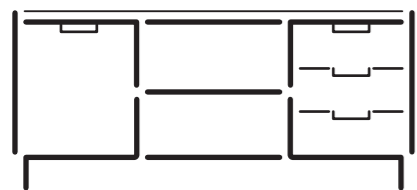

MAO

Todo a mano

Almacenaje

Módulo auxiliar

MÓDULO AUXILIAR OPERATIVO LAMINADO, CON CAJONERA DE 3 CAJONES, ESTANTE Y PUERTA CORREDERA
MODULE AUXILIAIRE OPÉRATIF EN MÉLAMINÉ, INCLUT CAISSON À 3 TIROIRS, ÉTAGÈRE ET PORTE COULISSANTE
LAMINATE OPERATIVE AUXILIARY MODULE, WITH 3-DRAWER CHEST, SHELF AND SLIDING DOOR

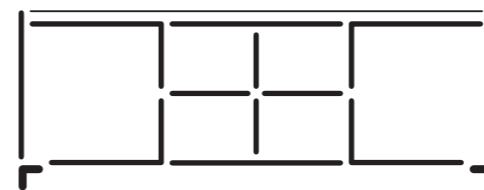

MAD

Próximo y versátil

Almacenaje

Módulo auxiliar

MÓDULO AUXILIAR DIRECCIONAL CON PUERTAS CORREDERAS Y ESTANTES. EN OPCIÓN MADERA O LAMINADO
MODULE AUXILIAIRE DIRECTIONNEL AVEC PORTES COULISSANTES ET ÉTAGÈRES. EN OPTION BOIS OU MÉLAMINÉ
EXECUTIVE AUXILIARY MODULE WITH SLIDING DOORS AND SHELVES. IN WOOD OR LAMINATE OPTION



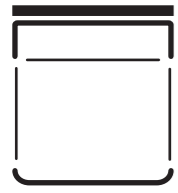

Backpack

El bolsillo de tu mesa

Almacenaje

Accesorio textil bajo mesa

ACCESORIO TEXTIL BAJO MESA, COMPUESTO DE PLUMIER EXTRAÍBLE Y SOPORTE METÁLICO INFERIOR
 ACCESSOIRE TEXTILE SOUS TABLE, COMPOSÉ D'UNE TROUSSE AMOVIBLE ET D'UN SUPPORT MÉTALLIQUE INFÉRIEUR
 TEXTILE UNDER-TABLE ACCESSORY, CONSISTING WITH SLIDING TRAY AND LOWER METAL SUPPORT

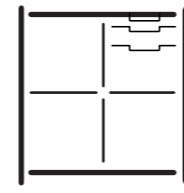

WS

Una extensión del orden

Almacenaje

Módulo extraíble

MÓDULO EXTRAÍBLE DE ESTANTES Y CAJONES QUE APORTA UNA MAYOR SUPERFICIE DE TRABAJO
 MODULE EXTRACTIBLE D'ÉTAGÈRES ET DE TIROIRS POUR AGRANDIR VOTRE ESPACE DE TRAVAIL
 SLIDING MODULE WITH SHELVES AND DRAWERS PROVIDING MORE WORKING SURFACE



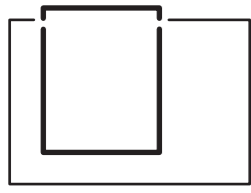

Mostradores

Tu primera imagen

DESARROLLAMOS MOSTRADORES DE DISEÑO SENCILLO Y PERSONALIZABLE
NOUS DEVELOPPONS DES BANQUES D'ACCUEIL AVEC UN DESIGN SIMPLE ET PERSONNALISABLE
WE DEVELOP RECEPTION DESKS WITH A SIMPLE AND CUSTOMIZABLE DESIGN



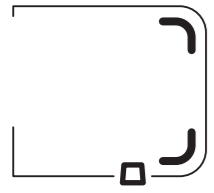

S-One

Panel acústico Slim

Paneles

Panel acústico

PANEL ACÚSTICO CON UN DISEÑO SIN COSTURAS Y NOTABLE RENDIMIENTO FONOABSORBENTE
 PANNEAU ACOUSTIQUE SANS COUTURES À PERFORMANCES D'ABSORPTION ACOUSTIQUE REMARQUABLES
 ACOUSTIC PANEL WITH SEAMLESS DESIGN AND REMARKABLE SOUND ABSORBING PERFORMANCE

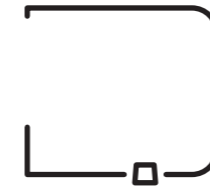

S-Two

Panel acústico Duo

Paneles

Panel acústico

PANEL ACÚSTICO. REDUCE EL NIVEL DE RUIDOS SUBYACENTES
 PANNEAU ACOUSTIQUE. RÉDUIT LE NIVEAU DE BRUITS SOUS-JACENTS
 ACOUSTIC PANEL DIVIDER. REDUCES UNDERLYING NOISE LEVELS



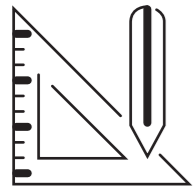

A medida

¿Qué necesitas?

NOS ADAPTAMOS A TU PROYECTO. OFRECEMOS SOLUCIONES A MEDIDA PARA PERSONALIZAR TU ESPACIO
NOUS NOUS ADAPTONS A VOTRE PROJET, ET VOUS OFFRONS DES SOLUTIONS PERSONNALISÉES POUR ÉQUIPEMENTS DE BUREAUX
WE ADAPT OURSELVES TO YOUR PROJECT OFFERING CUSTOMIZED SOLUTIONS TO ALL WORKSPACES





Acabados

Tu elección marca la diferencia

MELAMINA / MÉLAMINE / MELAMINE



B3
Blanco / Blanc / White



DP
Dauphin



AL
Aluminio / Aluminium

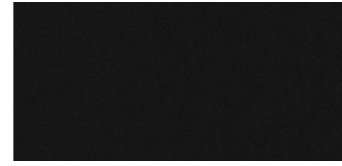

NM
Negro Mate / Noir Mat / Matt Black



RZ
Roble Azabache / Chêne Noir
Jet Oak



AA
Arce Americano / Érable Américain
American Maple



RA
Roble Aurora / Chêne Aurora
Aurora Oak



R6
Roble 06 / Chêne 06 / Oak 06



NS
Nogal Siena / Noyer Terre de Sienn
Siena Walnut

MADERA BARNIZADA / PLACAGE BOIS VERNI / WOOD VENEER



MR6
Roble 06 / Chêne 06 / Oak 06



MTE
Teca / Thèque / Teak

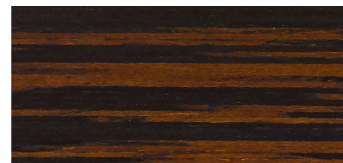

MEB
Ébano / Ébène / Ebony

RANURADO / RAINURÉ / GROOVED



RA
Roble Aurora / Chêne Aurora
Aurora Oak

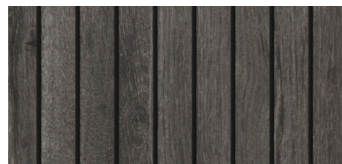

RZ
Roble Azabache / Chêne Noir
Jet Oak

METAL EPOXI / MÉTAL EPOXY / EPOXY METAL - G1



B3
Blanco / Blanc / White



DP
Dauphin Ral 7035



AT
Aluminio Texturado / Aluminium
Texturé / Textured Aluminium

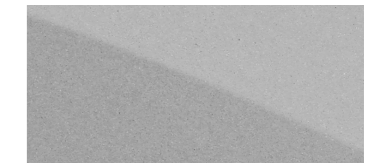

AL
Aluminio / Aluminium
Ral 9006

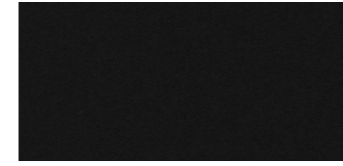

NM
Negro Mate / Noir Mat / Matt Black

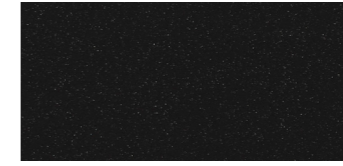

NE
Negro Texturado / Noir Texturé
Textured Black

METAL EPOXI / MÉTAL EPOXY / EPOXY METAL - G2



GP
Gris Piedra / Gris Pierre
Stone Grey - Ral 7032



BE
Beige
Ral 1019



MZ
Mostaza / Moutarde / Mustard
Ral 1032



SM
Salmón / Saumon / Salmon
Ral 3012



BD
Burdeos / Bordeaux / Burgundy
Ral 3005



VS
Verde Salvia / Vert Sauge
Sage Green



VO
Verde Oliva / Vert Olive
Olive Green - Ral 6003



TQ
Turquesa / Turquoise
Ral 5018

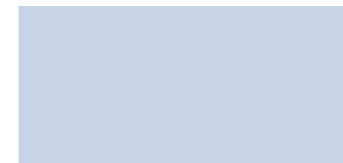

AB
Azul Nube / Bleu Nuage
Cloud Blue



AM
Azul Marino / Bleu Marine
Navy Blue - Ral 5011

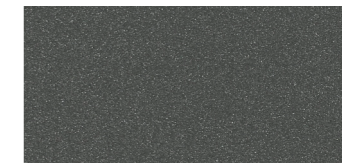

TI
Titanio / Titane / Titanium

TAPIZADOS / TISSUS / UPHOLSTERY - S-ONE

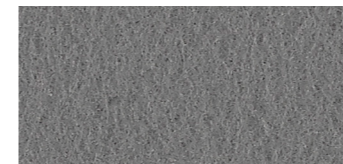

SLIM / 494
Gris / Grey



SLIM / 474
Naranja Arizona / Arizona Orange
Orange Arizona

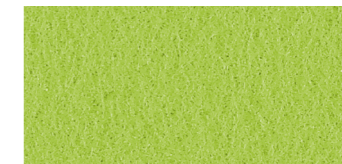

SLIM / 446
Verde / Vert / Green

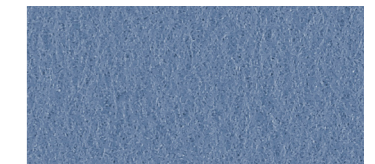

SLIM / 452
Azul / Bleu / Blue

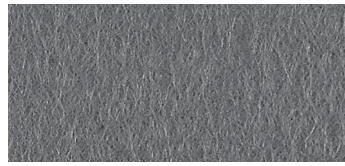

DUO / 202
Gris / Grey

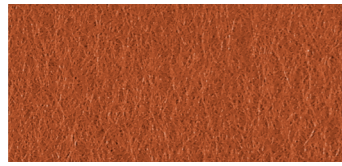

DUO / 239
Naranja Arizona / Arizona Orange
Orange Arizona



DUO / 234
Verde Oliva / Vert Olive
Olive Green

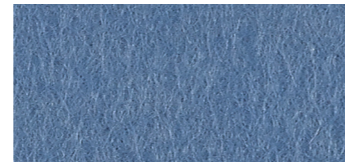

DUO / 225
Azul / Bleu / Blue

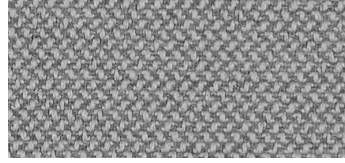

ERA / E11
Gris / Grey



ERA / E01
Beige

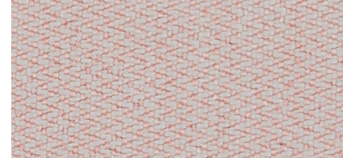

ERA / E19
Salmón / Saumon / Salmon



ERA / E20
Azul Cielo / Bleu Ciel / Sky Blue

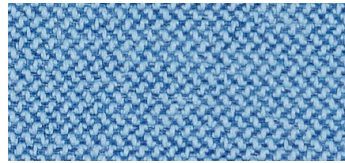

ERA / E08
Azul / Bleu / Blue

PET ACÚSTICO / PET ACOUSTIQUE / ACOUSTIC PET - S-THREE



104
Blanco / Blanc / White

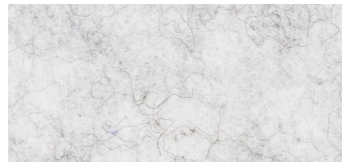

138
Gris Calacatta / Calacatta Grey

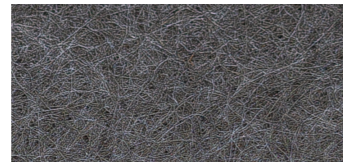

123
Gris Luna / Gris lunaire / Moon grey

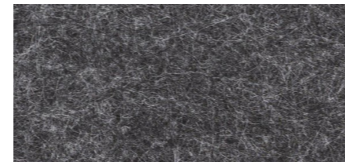

125
Gris Antracita / Gris Anthracite
Anthracite Grey



127
Negro / Noir / Black



101
Dorado Calacatta / Doré Calacatta
Calacatta Gold



107
Arena / Sable / Sand

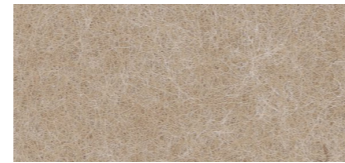

112
Beige

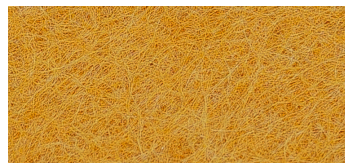

149
Mostaza / Moutarde / Mustard



131
Salmón / Saumon / Salmon

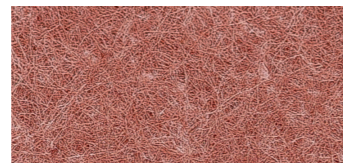

108
Terracota

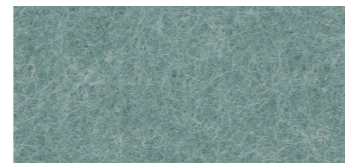

140
Verde Salvia / Vert Sauge
Sage Green

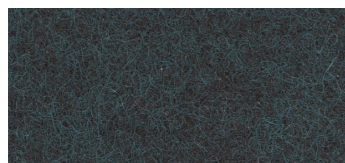

139
Verde Oscuro / Vert Foncé
Dark Green

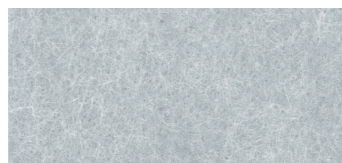

136
Azul Pálido / Bleu Pâle / Pale Blue

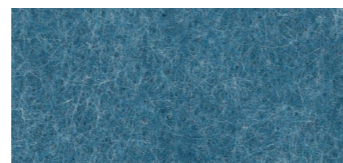

124
Azul Esmeralda / Bleu Émeraude
Emerald Blue

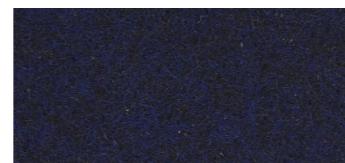

116
Azul Marino / Bleu Marine
Navy Blue

 Material PET reciclable, puede sufrir alteraciones de color
Matériau PET recyclable, peut subir des changements de couleur
PET recyclable material, may suffer color changes



B3
Blanco 9003 / Blanc 9003
White 9003



DP
Dauphin



AL
Aluminio / Aluminium



AN
Antracita / Anthracite



NE
Negro / Noir / Black

METACRILATO / METHACRYLATE / PLEXIGLASS

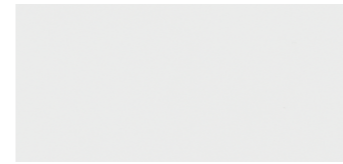

BN
Blanco Nieve / Blanc Neige
Snow White

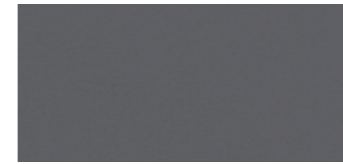

GR
Gris / Grey



CY
Cherry



KW
Kiwi



IB
Ice Blue

Todos los acabados no son compatibles con todas las series, para más información consultar tarifa.
Los colores y materiales mostrados pueden diferir ligeramente de la realidad debido a los límites de impresión.

Toutes les finitions ne sont pas compatibles avec toutes les séries. Pour plus d'informations, veuillez consulter le tarif. Les couleurs et les matériaux présentés peuvent différer légèrement de la réalité en raison des limites du système d'impression.

Not all finishes are compatible with all series, for more information see price list.
The colors and materials shown may differ slightly from reality, due to the printing limits.



Sostenibilidad

Buenas prácticas medioambientales



Sistema de Gestión
 ISO 9001:2015
 ISO 14001:2015
 ISO 14006:2011
 www.tuv.com
 ID 1100008125

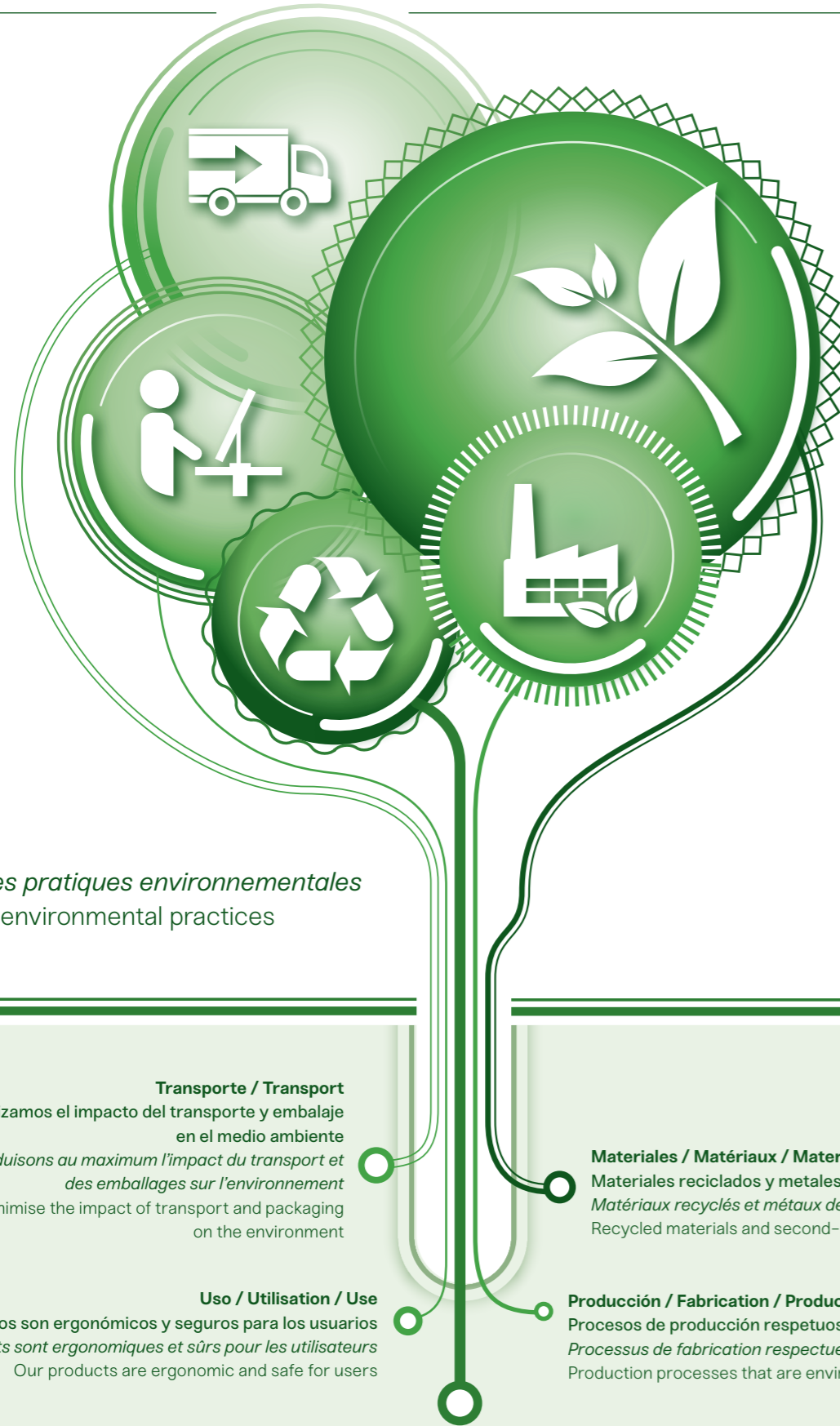

Bonnes pratiques environnementales
 Good environmental practices

Transporte / Transport

Minimizamos el impacto del transporte y embalaje en el medio ambiente
Nous réduisons au maximum l'impact du transport et des emballages sur l'environnement
 We minimise the impact of transport and packaging on the environment

Uso / Utilisation / Use

Nuestros productos son ergonómicos y seguros para los usuarios
Nos produits sont ergonomiques et sûrs pour les utilisateurs
 Our products are ergonomic and safe for users

Reciclable / Recyclable

Los componentes de nuestros muebles son fácilmente separables y reciclables
Les composants de nos meubles sont facilement démontables et recyclables
 The components in our furniture are easy to separate out and recycle

Materiales / Matériaux / Materials

Materiales reciclados y metales de segunda fusión
Matériaux recyclés et métaux de seconde fusion
 Recycled materials and second-melt metals

Producción / Fabrication / Production

Procesos de producción respetuosos con el medio ambiente
Processus de fabrication respectueux de l'environnement
 Production processes that are environmentally friendly

Disponemos desde hace años de la certificación de calidad **ISO 9001** y del sello **TECNALIA**, entidad que verifica y homologa las materias primas y el cumplimiento de las diferentes normativas europeas aplicables al mobiliario de oficina. En política de respeto al medioambiente, hemos implementado y certificado todas las medidas recogidas en la normas **ISO 14001** e **ISO 14006**.

El cumplimiento de todas estas normas facilita la obtención de puntos **LEED** con nuestros productos.

*Notre société dispose depuis plusieurs années, du certificat de qualité **ISO 9001**, et du label **TECNALIA**, entité qui vérifie et homologue les matières premières, et certifie la conformité aux différentes normes européennes applicables au mobilier de bureau.*

*En ce qui concerne notre politique de respect pour l'environnement, nous avons implanté et certifié toutes les directives recueillies dans les normes **ISO 14001** et **ISO 14006**.*

*La conformité à toutes ces normes, facilite l'obtention de points **LEED** avec nos produits.*

Our company has had the quality certification **ISO 9001** and **TECNALIA** for years, which verifies and standardizes raw material and compliance with European norms applicable to office furniture. Regarding to environmental policy, our company has implemented and certified all the measures contained in the **ISO 14001** and **ISO 14006**.

Compliance with these standards facilitates obtaining **LEED** points with our products.

JG Open Systems
Barcelona / España
Tel. +34 935 443 434
jggroup@jggroup.com



jggroup.com